

version .0

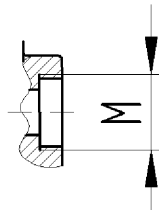
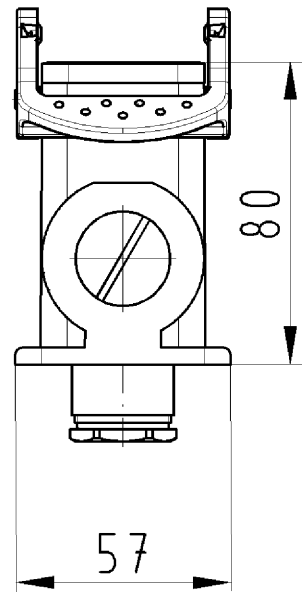
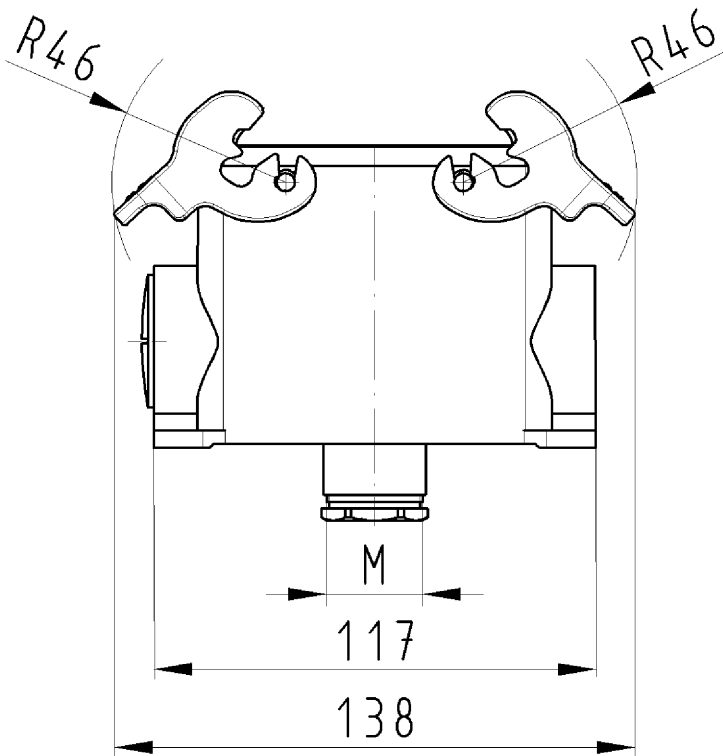

version .1

Gehäuseunterteil  
73.333.4035.0

Zeichnungsnummer  
73.333.4035.010W  
Gehäuseunterteil

13.12.2007  
Hoffmann Angelika  
M 1:2